

OPERATING INSTRUCTIONS RC102C



Please maintain these instructions and review them before using the unit:

Warning:

1. This unit is panel mounted type with its output terminals getting connected to the host equipment. Such equipment shall also comply with basic EMI/EMC and safety requirements like BSEN 61326-1 and BSEN 61010 respectively.
2. To avoid electric shock, power supply of the unit should be kept off while wiring. Wiring should be done strictly as per the terminal layout, given in the manual.
3. Use lugged terminals to meet M3.5 screws.
4. The unit does not have a built-in fuse. External fuse with a rating of 275V AC/1A is recommended.

Caution:

1. This unit is not intended for outdoor use.
2. The power connection cable must have a cross-section of atleast 1mm² and insulation capacity of atleast 1.5kV.
3. The output connections must not be loaded beyond the specified values/range.
4. Avoid inflow of dust and contact of conductive material with the internal circuitry of the unit.
5. The unit must not operate in presence of heating sources, caustic vapors, oil, steam, vibration or impact etc.
6. Use clean soaked cloth cleaning.

SPECIFICATIONS:

DISPLAY

Type: 7 segment LED; Height: 0.5".
Counter: 6 digits, Rate: 4 digits.

RANGE

Counter: 9999.99, 99999.9 & 999999.
Rate: Auto ranging (4.00 to 9999 RPM).

ACCURACY

Rate: 0.05 % (± 2 count).

SCALE FACTOR

Programmable from 0.00001 to 9.99999x10ⁿ
n = -3, -2, -1, 0, 1, 2.

INPUTS

3-30V DC from Proximity switches, Encoders,
Potential free contacts, Limit switches etc.

SENSOR SUPPLY

In built 12V DC (±10%), 30 mA

INPUT SPEED

- 1) 30 Hz
- 2) 2.5 kHz.

CONFIGURATION LOCK

via rear terminals.

RESET

- 1) On front panel.
- 2) Remote reset (via rear terminals).

MEMORY RETENTION

10 years.

SUPPLY VOLTAGE (FACTORY SET)

90 to 270V AC/DC @ 50/60 Hz.
24V AC/DC (Optional)

OPERATING TEMP.

Operating: 0 to 50°C
Storage: 0 to 50°C

HUMIDITY

95% RH.

HOUSING

Flame retardant plastic.

WEIGHT

250 gms.

PANEL DIMENSIONS(dimensions in mm)

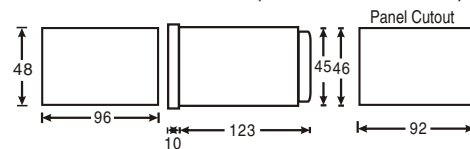

MODEL	DIM	A	B	C	D	E	F	G
RC102C		50	97.5	10	88	45	46	92

TERMINAL CONNECTION

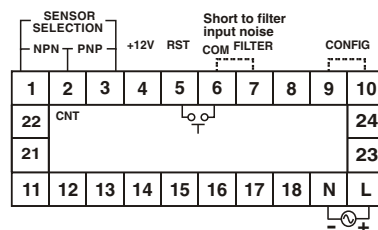

Description	Terminal
Short to select NPN sensor	1 - 2
Short to select PNP sensor	2 - 3
Count input	2
+12V supply	4
COM (GND)	6
Reset input	5 - 6
Short to Filter input noise	6 - 7
Short to enter configuration	9 - 10
Live - Neutral	L (+) - N (-)

INPUT CONNECTIONS:

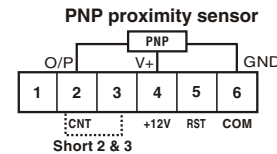

NOTE: For PNP sensor input, short terminals 2 & 3.

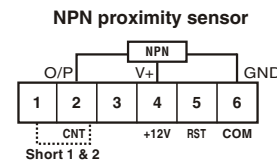

NOTE: For NPN sensor input, short terminals 1 & 2.

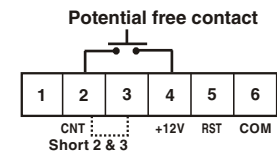

NOTE: Short terminals 2 & 3.

Sensor color codes:-

Red = +12V, Green = CNT, Black = GND;
Brown = +12V, Black = CNT, Blue = GND.

NOTE:

In some applications, the proximity sensors may pick up high frequency noise from nearby switching circuits like AC / DC drive. Due to this the counter may show erroneous reading. Short terminals 6-7 for RC102C as shown in figure above, to filter out high frequency spurious pulses by limiting the input frequency to about 200Hz (1200 RPM).

RATE OR TOTAL DISPLAY MODE:

The RC102C toggles between RATE display and TOTAL display at the momentary press of R/T (R/T) key. In rate mode RATE LED glows & in totaliser mode TOTAL LED glows.

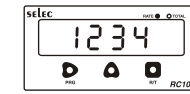

RATE

press (R/T) key momentary

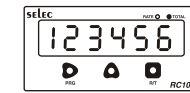

TOTAL

RESETTING THE RC102C

A. By front key: Press R/T (R/T) key continuously for 3 sec. The totaliser resets to zero and starts counting again, and the display shows the rate or total as per selection.

B. Remote reset:

The RC102C can be reset from a remote push button as shown in the figure below:

Reset by potential free switch

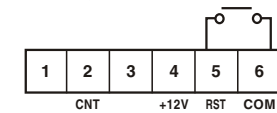

INITIALISATION:

Switch off the power. Short terminal no. 9 & 10. Press (R/T) key at the time of turning the power on. The key must continue to remain pressed for another 3 sec. When this sequence is correctly performed, the unit initialises and all parameters are set to factory settings.

Scale factor changes to 1 (mantissa = 1.0000 & exponent = 10⁰=1), Resolution = 1, Maximum input frequency = 2500 Hz. Totaliser resets to 0.

After initialisation unit will go into configuration setting mode. To quit configuration setting mode:

- 1) Turn power off
- 2) Remove link between terminal nos 9 & 10
- 3) Turn power on.

CONFIGURATION SCHEME

To enter configuration short terminals 9 & 10 and turn the power on.
Configure the unit as per the instructions below.

1. To select scale factor mantissa

KEY PRESS	DISPLAY	DESCRIPTION
-----------	---------	-------------

Scale factor mantissa	1000000	Set between 0.00001 to 9.99999 as described below:
-----------------------	---------	--

The blinking digit increments by 1 for every press of the \blacktriangle key & rolls over from 9 to 0. The blinking digit shifts to next digit (right) for every press \blacktriangleright of key. Using these keys user can set the required value.

2. Press R/T \blacksquare key to select scale factor exponent

Scale factor exponent	0	$10^0 = 1$
Press \blacktriangle	1	$10^1 = 10$
Press \blacktriangle	2	$10^2 = 100$
Press \blacktriangle	- 3	$10^{-3} = 0.001$
Press \blacktriangle	- 2	$10^{-2} = 0.01$
Press \blacktriangle	- 1	$10^{-1} = 0.1$

3. Press R/T \blacksquare key to select totaliser resolution

Totaliser resolution	1	Least count = 1
Press \blacktriangle	0.1	Least count = 0.1
Press \blacktriangle	0.01	Least count = 0.01

4. Press R/T \blacksquare key to select max. input frequency

Max. input frequency	2 2500	Fast speed (maximum 2500 hz)
Press \blacktriangle	2 30	Slow speed (maximum 30 hz)

5. Press R/T \blacksquare key to complete setting, display will go to step 1 (scale factor mantissa setting).

To quit configuration:

- 1) Turn power off.
- 2) Remove link between terminal no 9 & 10.
- 3) Turn power on.

TO READ SCALE FACTOR , RESOLUTION & SPEED

KEY PRESS (MOMENTARY)	DISPLAY	NAME / DESCRIPTION
\blacktriangleright PRG	1000000	Scale Factor (Mantissa)
\blacktriangleright PRG	0	Scale Factor (Exponent)
\blacktriangleright PRG	1 1	Totaliser Least Count
\blacktriangleright PRG	2 2500	Maximum Input Speed

NOTE: Maximum display time is 3 sec. If the key is pressed again within 3 sec of previous key press, display shows next parameter, otherwise it shows rate or total as per selection.

TYPICAL APPLICATION:

Objective: To display: a. The total length of cord (in meters) that has passed over the measuring wheel
b. The delivery rate of cord (meters / minute).

Data available:

The proximity switch generates 1 pulse / revolution of the measuring wheel. The diameter of the wheel is 10cm.

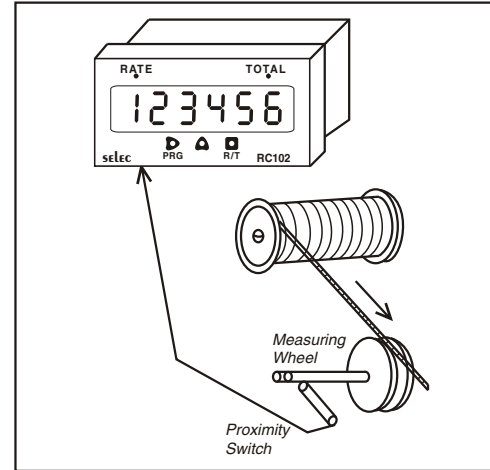

Calculations

Circumference of the wheel = $3.14285 \times 0.1 = 0.314285\text{m}$.

Therefore the length of rope delivered per revolution is 0.314285m.

Since the proximity switch gives one pulse per revolution, the display should increment by 0.314285 for every pulse. Therefore, scale factor = 0.314285.

Set scale factor mantissa = 3.14285 & exponent = 10^{-1}
The RC102C will show rate in meters / minute & total in meters.

Example 2: If 60 PPR encoder is fitted instead of proximity.

Length of rope delivered per revolution is 0.314285m.
Number of pulses per revolution = 60.

Length of rope delivered / pulse = $0.314285 / 60 = 0.005238\text{m}$.

The display should increment by 0.005238 for every pulse. Therefore, scale factor = 5.23800×10^{-3}

Set scale factor mantissa = 5.23800 & exponent = 10^{-3} for the required display.

Selec Controls Pvt. Ltd.

(Specifications are subject to change, since development is a continuous process)

Telephone: +91-22-40394200 / 40394202

Fax: +91-22-28471733

Toll free: 1800 227 353

Website: www.selec.com

Email: sales@selec.com

Operating/1108/RC102C/OP191-V04

(Page 2 of 2)